

SPECIFICATIONS / TECHNICAL DATA

SHOWER ENCLOSURE

HINGED FRAMELESS

42"

HANDLE DIMENSIONS

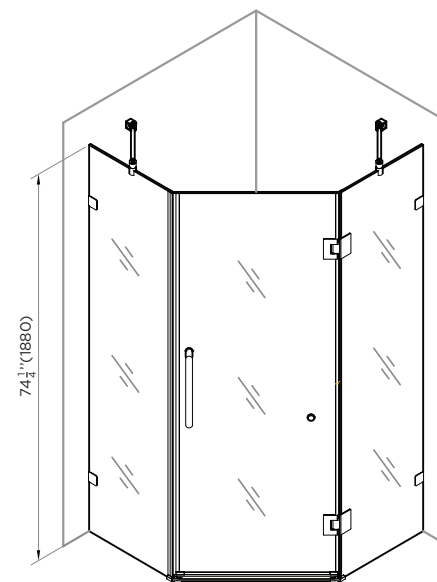
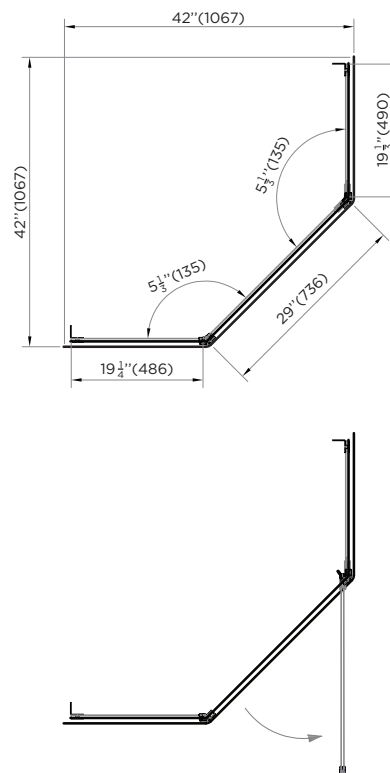
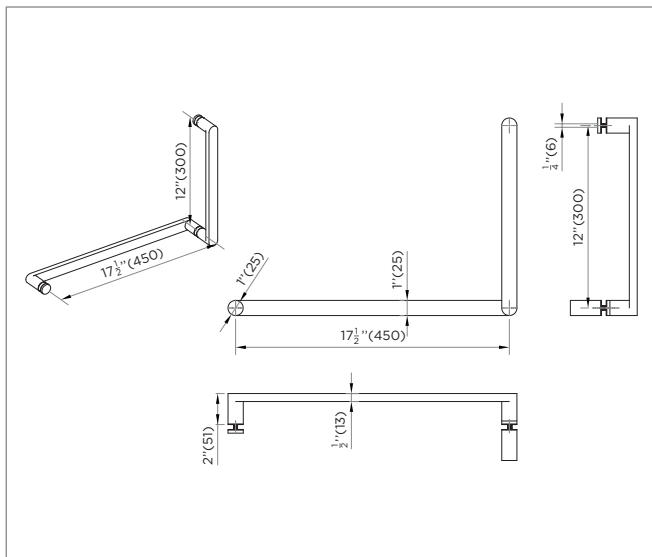

ATTENTION! Dimensions may vary by up to 3/8". It is highly recommended to pull all dimensions of actual model for installation and measuring purposes.

MODEL# SENA1-42